

The image features two Daisy Red Ryder BB guns leaning against a weathered tree trunk in a grassy field. The guns have wooden stocks and black metal receivers. The background is a soft-focus landscape with green grass and trees under a blue sky with light clouds. The Daisy logo, a target with a red bullseye, is integrated into the letter 'D' of the brand name.

# Daisy<sup>®</sup>

# RED RYDER<sup>®</sup>

**IT ALL STARTS WITH DAISY.<sup>™</sup>**  
2020 Product Catalog



# RED RYDER®

Back to our roots! New redesigned packaging for Red Ryder® products now come in RETRO 1940s-style packaging that harkens back to the days of the wild West. Ride the range with Red Ryder®!



## Model 1938 Red Ryder®

**ACTION** Lever-cocking, spring air  
**BARREL** Smooth bore steel  
**SIGHTS** Blade and ramp front/Adjustable rear  
**STOCK/FOREARM** Stained solid wood  
**SAFETY** Crossbolt trigger block  
**CAPACITY** 650 shot



## Model 4938 Red Ryder® Fun Kit

**ACTION** Lever-cocking, spring air  
**BARREL** Smooth bore steel  
**SIGHTS** Blade and ramp front/Adjustable rear  
**STOCK/FOREARM** Stained solid wood  
**SAFETY** Crossbolt trigger block  
**CAPACITY** 650 shot

**KIT INCLUDES**  
 Precision Max® 750 count BB tin, Shooting glasses, Target fun pack

**NEW**



A beefed up, bigger stock means this Adult-sized Red Ryder® fits like any other full-sized gun and lets you plink the target just like old times!

## Model 1938 Adult Red Ryder®

**ACTION** Lever-cocking, spring air  
**BARREL** Smooth bore steel  
**SIGHTS** Blade and ramp front/Adjustable rear  
**STOCK/FOREARM** Stained solid wood  
**SAFETY** Crossbolt trigger block  
**CAPACITY** 650 shot

Model No.	Ammunition	Max. Velocity	Max. Shooting Distance	Overall Length	Weight	Item No.	Packaging & Pack Size (W/D/H)	Master Pack	Master Cu. Ft.	Master Weight	UPC	MSRP
1938	.177 cal. (4.5 mm) BB	350 fps	195 yds.	35.4"	2.2 lbs.	991938	Box; Individual 37.2x2x5 Master 38x5.7x6.6	3	0.82	11.6	0 39256 01938 2	\$39.99
4938	.177 cal. (4.5 mm) BB	350 fps	195 yds.	35.4"	2.2 lbs.	994938	Box; Individual 37.3x2.3x5 Master 38.3x5.5x7.2	3	0.867	13	0 39256 84938 5	\$49.99
1938 ADULT	.177 cal. (4.5 mm) BB	350 fps	195 yds.	37.75"	3.25 lbs.	991938-ARR	Box; Individual 0x0x0 Master 0x0x0				0 39256 30938 4	

## Model 3163 Red Ryder® Starter Kit

### KIT INCLUDES

350-count Red Ryder® BB tube, Red Ryder® shooting glasses, Red Ryder® Gun Sleeve, 25 ASSORTED Red Ryder® shooting gallery targets.



## Model 3164 Shooting Gallery Target Box

Inside or outside, the Daisy® Red Ryder® Shooting Gallery helps you improve accuracy while providing hours of fun. Plus, it's easy to use. Simply punch out the perforated front portion of the box, hang a target (included) put on your shooting glasses and start shooting. Fun with a group or by yourself – in the backyard or basement.

### KIT INCLUDES

25 ASSORTED Red Ryder® shooting gallery targets

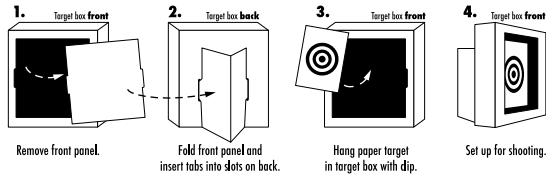

## Model 3166 Shooting Gallery Target Box Kit

Inside or outside, the Daisy® Red Ryder® Shooting Gallery helps you improve accuracy while providing hours of fun. Plus, it's easy to use. Simply punch out the perforated front portion of the box, hang a target (included) put on your shooting glasses and start shooting. Fun with a group or by yourself – in the backyard or basement.

### KIT INCLUDES

25 ASSORTED Red Ryder® shooting gallery targets  
350 count Red Ryder® BB tube  
Red Ryder® shooting glasses  
Red Ryder® Gun Sleeve



## Model 3165 Red Ryder® Shooting Gallery Targets

### KIT INCLUDES

25 ASSORTED Red Ryder® shooting gallery targets



## Model 3162 Red Ryder® Gun Sleeve

Rugged red nylon gun sleeve with carry handles, zipper and great retro Red Ryder® graphic. 40" length fits most Daisy youth rifles and PowerLine rifles.



Model No.	Description	Item No.	Packaging & Pack Size (W/D/H)	Master Pack	Master Cu. Ft.	Master Weight	UPC	MSRP
3163	Red Ryder Starter Kit	993163	Individual 0x0x10 Master 10x9.5x6	4	0.30	4	0 39256 03163 6	\$9.69
3164	Red Ryder Shooting Gallery Target Box	993164	Individual 0x0x10 Master 14x9.25x13.5	2	0.90	2.6	0 39256 03164 3	\$9.69
3166	Red Ryder Shooting Gallery Target Box and Starter Combo	993166	Individual 0x0x10 Master 14x9.25x13.5	4	1.91	7.6	0 39256 83166 3	\$16.76
3165	Red Ryder Shooting Gallery Targets	993165	Individual 0x0x10 Master 11.37x6.5x1.125	6		0.54	0 39256 83165 6	\$3.12
3162	Red Ryder Air Rifle Sleeve	993161	(Peggable); Individual 6.5x1.3x11.2 Master 11.3x8.5x5.4	6	0.30	2.26	0 39256 03162 9	\$9.99



# Youth Rifles



# BOY SCOUTS OF AMERICA®

Official BB Gun of the Boy Scouts of America



Components of this product are made using a closed loop recycling process.



## Model BSAK1910

ACTION	Single pump pneumatic
BARREL	Smooth bore steel
SIGHTS	Blade and ramp front/Adjustable rear
STOCK/FOREARM	Molded stock & forearm with checkering
SAFETY	Crossbolt trigger block
CAPACITY	50 shot/BB; Single shot/pellet

## The Classic Model 25 Pump Gun

A LEGEND SINCE 1914

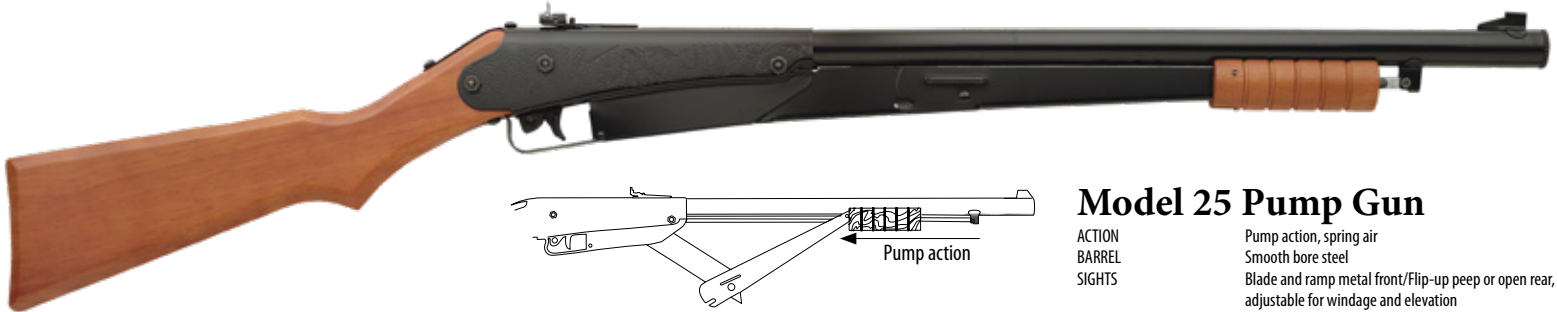

## Model 25 Pump Gun

ACTION	Pump action, spring air
BARREL	Smooth bore steel
SIGHTS	Blade and ramp metal front/Flip-up peep or open rear, adjustable for windage and elevation
STOCK/FOREARM	Stained solid wood
SAFETY	Crossbolt trigger block
CAPACITY	50 shot

Daisy's popular Model 25 Pump Gun, first built in 1914, remained a part of the company's airgun line through 1978. A special Centennial Limited Edition, produced in 1986, commemorated the 100th anniversary of Daisy®. Today's Model 25 Pump Gun carries on the tradition, with features found on some of the earlier models: Solid wood pistol grip stock and forearm grip, metal construction, removable screw-in shot tube and fully-adjustable, flip-up peep and open rear sights. The Model 25 Pump Gun legend continues.

Model No.	Ammunition	Max. Velocity	Max. Shooting Distance	Overall Length	Weight	Item No.	Packaging & Pack Size (W/D/H)	Master Pack	Master Cu. Ft.	Master Weight	UPC	MSRP
BSAK1910	.177 cal. (4.5 mm) BB or pellet	350 fps (BB)	211 yds.	34.5"	3.1 lbs.	BSAK1910	Box; Individual 37.1x2.2x7.5 Master 38x5.7x7.5	3	0.94	11.94	0 39256 81910 4	
25	.177 cal. (4.5 mm) BB	350 fps	195 yds.	36.5"	3 lbs.	990025	Box; Individual 37.9x2.0x5.7 Master 38.8x6.2x6.6	3	0.9	13.94	0 39256 80025 6	\$49.99

# Youth Rifles

## Model 105 Buck™

ACTION Lever-cocking, spring air  
 BARREL Smooth bore steel  
 SIGHTS Blade and ramp front/ Fixed open rear  
 STOCK/FOREARM Stained solid wood  
 SAFETY Crossbolt trigger block  
 CAPACITY 400 shot

## Model 4105 Buck™ Fun Kit

ACTION Lever-cocking, spring air  
 BARREL Smooth bore steel  
 SIGHTS Blade and ramp front/ Fixed open rear  
 STOCK/FOREARM Stained solid wood  
 SAFETY Crossbolt trigger block  
 CAPACITY 400 shot

## Model 1999 Pink Lever Action Carbine

ACTION Lever-cocking, spring air  
 BARREL Smooth bore steel  
 SIGHTS Fiber optic front sight/Adjustable rear  
 STOCK/FOREARM All-weather synthetic  
 SAFETY Crossbolt trigger block  
 CAPACITY 650 shot

## Model 4998 Fun Kit

ACTION Lever-cocking, spring air  
 BARREL Smooth bore steel  
 SIGHTS Fiber optic front sight/Adjustable rear  
 STOCK/FOREARM All-weather synthetic  
 SAFETY Crossbolt trigger block  
 CAPACITY 650 shot

### KIT INCLUDES

Precision Max® 750 count BB tin, Pink shooting glasses, Target fun pack

## Model 1999 Camo Lever Action Carbine

ACTION Lever-cocking, spring air  
 BARREL Smooth bore steel  
 SIGHTS Fiber optic front sight/Adjustable rear  
 STOCK/FOREARM All-weather synthetic  
 SAFETY Crossbolt trigger block  
 CAPACITY 650 shot

## Model 2840 with 4X15 Scope

ACTION Single pump pneumatic  
 BARREL Smooth bore steel  
 SIGHTS Blade and ramp front/Adjustable rear  
 STOCK/FOREARM Molded with checkering and woodgrain with camo  
 SAFETY Crossbolt trigger block  
 CAPACITY 350 shot/BB; Single shot/pellet



**NEW**



**FEATURING**  
LOOP LEVER

**FIBER OPTIC**  
SIGHT

**NEW**



**FEATURING**  
LOOP LEVER

**FIBER OPTIC**  
SIGHT

**NEW**



**FEATURING**  
LOOP LEVER

**DUAL**  
AMMO  
PELLET OR BB

Model No.	Ammunition	Max. Velocity	Max. Shooting Distance	Overall Length	Weight	Item No.	Packaging & Pack Size (W/D/H)	Master Pack	Master Cu. Ft.	Master Weight	UPC	MSRP
105	.177 cal. (4.5 mm) BB	350 fps	195 yds.	29.8"	1.6 lbs.	992105	Box; Individual 31.1x1.5x4.5 Master 32x5x5	3	0.48	7.94	0 39256 02105 7	\$29.99
4105	.177 cal. (4.5 mm) BB	350 fps	195 yds.	29.8"	1.6 lbs.	994105	Box; Individual 0x0x0 Master 31.75x5x7	3	0.48	10.1	0 39256 84105 1	\$34.99
1999 Pink	.177 cal. (4.5 mm) BB	350 fps	195 yds.	35.4"	2.2 lbs.	991999-503	Box; Individual 0x0x0 Master 0x0x0	3			0 39256 81940 1	
4999 Pink Kit	.177 cal. (4.5 mm) BB	350 fps	195 yds.	35.4"	2.2 lbs.	994999-403	Box; Individual 0x0x0 Master 0x0x0	3			0 39256 74999 9	
1999 Camo	.177 cal. (4.5 mm) BB	350 fps	195 yds.	35.4"	2.2 lbs.	991999-603	Box; Individual 0x0x0 Master 0x0x0	3			0 39256 21999 7	
2840	.177 cal. (4.5 mm) BB or pellet	350 fps (BB)	211 yds.	34.5"	3.1 lbs.	992840	Box; Individual 37.1x2.2x7.5 Master 38x5.7x7.5	3	0.94	11.94	0 39256 82840 3	\$59.99



# PowerLine Rifles



Since its introduction in 1972, the Daisy® PowerLine® 880 has been the benchmark for high power multi-pump pneumatic air rifles. Renowned reliability and durability make the 880 one of the most respected air rifles for shooters today.



## Model 880

**ACTION** Multi-pump pneumatic  
**BARREL** Rifled steel  
**SIGHTS** Fiber optic front/ Adjustable rear  
**STOCK/FOREARM** Monte Carlo style molded woodgrain  
**SAFETY** Crossbolt trigger block  
**CAPACITY** 50 shot/BB; Single shot/pellet



## Model 880 with 4 X 15 Scope

**ACTION** Multi-pump pneumatic  
**BARREL** Rifled steel  
**SIGHTS** Blade and ramp front/Adjustable  
**STOCK/FOREARM** Monte Carlo style molded woodgrain  
**SAFETY** Crossbolt trigger block  
**CAPACITY** 50 shot/BB; Single shot/pellet



## Model 5880 Kit

**ACTION** Multi-pump pneumatic  
**BARREL** Rifled steel  
**SIGHTS** Blade and ramp front/Adjustable rear  
**STOCK/FOREARM** Monte Carlo style molded woodgrain  
**SAFETY** Crossbolt trigger block  
**CAPACITY** 50 shot/BB; Single shot/pellet

**KIT INCLUDES**  
 4 X 15 scope • Precision Max® 750 count BB tin • Precision Max® 500 count pellet tin • Shooting glasses

Model No.	Ammunition	Max. Velocity	Max. Shooting Distance	Overall Length	Weight	Item No.	Packaging & Pack Size (W/D/H)	Master Pack	Master Cu. Ft.	Master Weight	UPC	MSRP
880	.177 cal. (4.5 mm) BB or pellet	800 fps (BB)	291 yds.	37.6"	4.75 lbs.	990880	Box; Individual 38.9x2.3x5.5 Master 40x5.5x6	3	1.08	14.25	0 39256 00880 5	\$49.99
880S	.177 cal. (4.5 mm) BB or pellet	800 fps (BB)	291 yds.	37.6"	4.97 lbs.	992880	Box; Individual 38.7x2.3x5.5 Master 39.8x5.3x6.2	3	1.08	14.92	0 39256 82880 9	\$59.99
5880	.177 cal. (4.5 mm) BB or pellet	800 fps (BB)	291 yds.	37.6"	5.78 lbs.	985880	Box; Individual 38.7x2.3x5.5 Master 39.8x5.3x6.2	3	1.06	18.53	0 39256 05880 0	\$79.99

# POWERLINE®



  
Components of this product  
are made using a  
closed loop recycling process.

  
DUAL  
AMMO  
PELLET OR BB

## Model 35 Camo

**ACTION** Multi-pump pneumatic  
**BARREL** Smooth bore steel  
**SIGHTS** Blade and ramp front/Adjustable rear  
**STOCK/FOREARM** Molded stock & forearm with checkering with camo  
**SAFETY** Crossbolt trigger block  
**CAPACITY** 50 shot/BB; Single shot/pellet



  
Components of this product  
are made using a  
closed loop recycling process.

  
DUAL  
AMMO  
PELLET OR BB

## Model 35

**ACTION** Multi-pump pneumatic  
**BARREL** Smooth bore steel  
**SIGHTS** Blade and ramp front/Adjustable rear  
**STOCK/FOREARM** Molded stock & forearm with checkering  
**SAFETY** Crossbolt trigger block  
**CAPACITY** 50 shot/BB; Single shot/pellet



  
DUAL  
AMMO  
PELLET OR BB  
  
FIBER OPTIC  
SIGHT

## Model 901

**ACTION** Multi-pump pneumatic  
**BARREL** Rifled steel  
**SIGHTS** Fiber optic front/ Adjustable open rear  
**STOCK/FOREARM** Black composite  
**SAFETY** Crossbolt trigger block  
**CAPACITY** 50 shot/BB, Single shot/pellet



  
DUAL  
AMMO  
PELLET OR BB  
  
FIBER OPTIC  
SIGHT

## Model 5901 Kit

**ACTION** Multi-pump pneumatic  
**BARREL** Rifled steel  
**SIGHTS** Fiber optic front/ Adjustable open rear  
**STOCK/FOREARM** Black composite  
**SAFETY** Crossbolt trigger block  
**CAPACITY** 50 shot/BB, Single shot/pellet

**KIT INCLUDES**  
4 X 15 Air rifle scope  
Shooting glasses  
Eight ShatterBlast® breakable clay targets and two target holders  
PrecisionMax® 750 count BB tin  
PrecisionMax® 500 count pellet tin

Model No.	Ammunition	Max. Velocity	Max. Shooting Distance	Overall Length	Weight	Item No.	Packaging & Pack Size (W/D/H)	Master Pack	Master Cu. Ft.	Master Weight	UPC	MSRP
35 Camo	.177 cal. (4.5 mm) BB or pellet	625 fps (BB)	274 yds.	34.5"	3.1 lbs.	993035	Box; Individual 37.1x2.2x7.5 Master 38x5.7x7.5	3	0.94	11.94	0 39256 23035 0	\$49.99
35	.177 cal. (4.5 mm) BB or pellet	625 fps (BB)	274 yds.	34.5"	3.1 lbs.	990035	Box; Individual 37.1x2.2x5 Master 38x5.6x7.3	3	0.93	11.80	0 39256 20035 3	\$39.99
901	.177 cal. (4.5 mm) BB or pellet	800 fps (BB)	291 yds.	37.5"	3.7 lbs.	990901	Box; Individual 38.7x2.3x6.75 Master 39.75x6.5x7.38	3	1.10	15.85	0 39256 80901 3	\$69.99
5901	.177 cal. (4.5 mm) BB or pellet	800 fps (BB)	291 yds.	37.5"	3.7 lbs.	985901	Box; Individual 38.7x2.3x7 Master 39.75x6.5x7.38	3	1.10	21.28	0 39256 85901 8	\$89.99



# PowerLine Pistols



## Model 415 CO2 Pistol **FIBER OPTIC SIGHT**

**ACTION** CO2 semi-automatic  
**BARREL** Smooth bore steel  
**SIGHTS** Fiber optic front/Fixed open rear  
**SAFETY** Manual trigger block  
**CAPACITY** 21-shot built-in BB magazine



## Model 415 CO2 Pistol Kit **FIBER OPTIC SIGHT**

**ACTION** CO2 semi-automatic  
**BARREL** Smooth bore steel  
**SIGHTS** Fiber optic front/Fixed open rear  
**SAFETY** Manual trigger block  
**CAPACITY** 21-shot built-in BB magazine

### KIT INCLUDES

Shooting glasses  
 PrecisionMax® 350 count BB tube  
 12-gram CO2 cylinders (3) Targets



Model No.	Ammunition	Max. Velocity	Max. Shooting Distance	Overall Length	Weight	Item No.	Packaging & Pack Size (W/D/H)	Master Pack	Master Cu. Ft.	Master Weight	UPC	MSRP
415	.177 cal. (4.5 mm) BB	495 fps	235 yds.	8.6"	0.93 lbs.	980415	Trapped Blister (Peggable); Individual 10x1.2x6.9 Master 10.5x7.5x4.3	2	0.24	2.51	0 39256 80415 5	\$39.99
415 Kit	.177 cal. (4.5 mm) BB	495 fps	235 yds.	8.6"	0.93 lbs.	985415	Trapped Blister (Peggable); Individual 14x9.5x2.75 Master 14x8x9.75	2	0.48	4.61	0 39256 85415 0	\$49.99



# POWERLINE®

## Model 408 CO2 Pistol

**ACTION** CO2 powered semi-automatic  
**BARREL** Rifled bore steel  
**SAFETY** Manual trigger block  
**SIGHTS** Blade white dot front, fixed open white 2-dot rear  
**CAPACITY** 8-shot removable clip



**10 DUAL AMMO**  
 PELLET OR BB

## Model 408 CO2 Pistol Kit

**ACTION** CO2 powered semi-automatic  
**BARREL** Rifled bore steel  
**SAFETY** Manual trigger block  
**SIGHTS** Blade white dot front, fixed open white 2-dot rear  
**CAPACITY** 8-shot removable clip



**10 DUAL AMMO**  
 PELLET OR BB

### KIT INCLUDES

Shooting glasses  
 PrecisionMax® 350 count BB tube  
 12-gram CO2 cylinders (3) Targets

## Model 426 CO2 Pistol

**ACTION** CO2 powered semi-automatic  
**CALIBER** .177 (4.5 mm) BB  
**SIGHTS** Blade and ramp front / Fixed open rear  
**CAPACITY** 15-shot built-in BB magazine  
**SAFETY** Manual trigger block  
**BARREL** Smooth bore steel



## Model 5501 CO2 Blowback Pistol

**ACTION** CO2 semi-automatic **BLOWBACK**  
**BARREL** Smooth bore steel  
**SIGHTS** Blade and ramp front/Open rear  
**SAFETY** Manual trigger block  
**CAPACITY** 15-shot clip



## Model 5170 CO2 Pistol

**ACTION** CO2 semi-automatic  
**BARREL** Smooth bore steel  
**SIGHTS** Blade and ramp front/Open rear  
**SAFETY** Manual trigger block  
**CAPACITY** 21-shot clip



PowerLine 5170 Pistol includes muzzle compensator and accessory rails for mounting sights and other accessories (not included)

## Model 340 Pistol

**ACTION** Spring air  
**BARREL** Smooth bore steel  
**SIGHTS** Blade and ramp front/Fixed open rear  
**SAFETY** Crossbolt trigger block  
**CAPACITY** 200-shot BB Reservoir with 13-Shot Speedload Clip



Model No.	Ammunition	Max. Velocity	Max. Shooting Distance	Overall Length	Weight	Item No.	Packaging & Pack Size (W/D/H)	Master Pack	Master Cu. Ft.	Master Weight	UPC	MSRP
408	.177 cal. (4.5 mm) BB or pellet	485 fps	260 yds.	7.75"	1.30 lbs.	981408	Trapped Blister (Peggable); Individual 10x1.2x6.9 Master 10.5x7.5x4.3	2	0.21	3.4	0 39256 20408 5	\$64.99
408 Kit	.177 cal. (4.5 mm) BB or pellet	485 fps	260 yds.	7.75"	1.30 lbs.	984408	Trapped Blister (Peggable); Individual 10x1.2x6.9 Master 10.5x7.5x4.3	2	0.45	6.5	0 39256 24408 1	\$79.99
426	.177 cal. (4.5 mm) BB	430 fps	209 yds.	6.875"	0.9 lbs.	980426	Trapped Blister (Peggable); Individual 10x1.2x6.9 Master 10.5x7.5x4.3	4	0.44	5.1	0 39256 20426 9	\$29.99
5170	.177 cal. (4.5 mm) BB	520 fps	254 yds.	9.5"	1.0 lbs.	995170	Trapped Blister (Peggable); Individual 11x2x8.2 Master 11.5x6.8x9	2	0.34	3.6	0 39256 85170 8	\$59.99
5501	.177 cal. (4.5 mm) BB	430 fps	209 yds.	6.8"	1.0 lbs.	985501	Trapped Blister (Peggable); Individual 11.2x1.3x8 Master 11.5x4.9x9	2	0.22	3.89	0 39256 85501 0	\$89.99
340	.177 cal. (4.5 mm) BB	240 fps	100 yds.	8.5"	1.0 lbs.	980340	Trapped Blister (Peggable); Individual 11.8x1.3x8.2 Master 12.8x3.2x9.4	2	0.26	2.46	0 39256 20340 8	\$24.99



# PowerLine Slingshots

## Model F16 Slingshot

Molded sure-grip handle and a solid steel frame with extra-wide fork. Latex rubber tubing with durable release pouch. Shoots 1/4" or 3/8" steel shot or 1/2" glass shot.

## Model B52 Slingshot

Molded sure-grip handle and solid steel frame with extra-wide fork. Flexible wrist support provides steady, stable support, then folds away for compact storage. Latex rubber tubing and rugged release pouch Shoots 1/4" or 3/8" steel shot or 1/2" glass shot.

## Model P51 Slingshot

Sleek, molded pistol-grip handle with flexible wrist support. Fully adjustable. Durable, latex rubber tubing and rugged release pouch delivers plenty of power. Shoots 1/4" or 3/8" steel shot or 1/2" glass shot.

## Model P51 Slingshot Kit

Sleek, molded pistol-grip handle with flexible wrist support. Fully adjustable. Durable, latex rubber tubing and rugged release pouch delivers plenty of power.

### KIT INCLUDES

Replacement bands  
75-count 3/8" steel ammo  
250-count 1/4" steel ammo

## Model 8114 1/4" Steel Slingshot Ammo

Solid steel shot is zinc plated. 250 per pack. Packed 6 per case.

## Model 8183 3/8" Steel Slingshot Ammo

Solid steel shot is zinc plated. 70 per pack. Packed 6 per case.

## Model 8383 1/2" Glass Slingshot Ammo

High visibility solid glass shot. 75 per mesh bag. Packed 12 per case.

## Model 8172 Slingshot Replacement Bands

Fits Models F16, B52 and P51.

Model F16



Model B52



Model P51



Model P51Kit



Model 8114



Model 8183



Model 8383



Model 8172



Model No.	Description	Item No.	Packaging & Pack Size (W/D/H)	Master Pack	Master Cu. Ft.	Master Weight	UPC	MSRP
F16	Slingshot	988116	<b>Trapped Blister</b> (Peggable); Individual 5.75x2.1x8.7 Master 10x8.1x6.4	4	0.30	2.04	0 39256 28116 1	\$7.99
B52	Slingshot	988152	<b>Trapped Blister</b> (Peggable); Individual 5.7x2.3x10.4 Master 13x5.1x11.3	4	0.43	3.30	0 39256 28152 9	\$10.99
P51	Slingshot	998151	<b>Box</b> ; Individual 4.9x4.75x10.8 Master 14.5x10.6x11.5	6	1.02	7.75	0 39256 88151 4	\$15.99
P51K	Slingshot Kit	988153	<b>Trapped Blister</b> (Peggable); Individual 11.5x4.3x13.1 Master 15.6x12.2x13.8	4	1.52	11.97	0 39256 28153 6	\$29.99
8114	1/4" Steel Slingshot Ammo	988114	<b>Trapped Blister</b> (Peggable); Individual 4.8x1.7x4.3 Master 10.7x5.4x5.6	6	0.19	4.31	0 39256 28114 7	\$4.99
8183	3/8" Steel Slingshot Ammo	988183	<b>Trapped Blister</b> (Peggable); Individual 4.8x1.5x4.2 Master 10.75x5.3x5.6	6	0.19	4.07	0 39256 28183 3	\$4.99
8383	1/2" Glass Slingshot Ammo	998383	<b>Bag</b> (Peggable); Individual 3x3x6.8 Master 8.6x8.5x6	12	0.25	7.55	0 39256 88338 9	\$4.99
8172	Slingshot Replacement Bands	988172	<b>Trapped Blister</b> (Peggable); Individual 3x1.5x6 Master 9x4.7x3.4	6	0.08	0.49	0 39256 28172 7	\$4.99



# Daisy Ammunition and CO2

## Not just better choices – better ammo.

Every shooter wants the best ammo possible, and thanks to our Precision Max® line of ammunition the choice is easier than ever. That's because all of our high-quality ammunition comes clearly marked in color-coded packaging, making it simple to find the calibers, quantities and type of ammunition you need. Choose from tins, traditional BB tubes, belt pack boxes, and new easy-dispensing bottles. Customer friendly packaging and performance that's second to none – that's Precision Max ammo.

## Ammunition

Model No.	Caliber	Description	Quantity	Item No.	Packaging & Pack Size (W/D/H)	Master Pack	Master Cu. Ft.	Master Weight	UPC	MSRP
7781	.177 cal. (4.5 mm)	Flat, Pointed & Hollow-point Pellets 100 each	300	987781	Trapped Blister (Peggable); Individual 5.45x8x4 Master 7x6.7x4.8	6	0.13	2.83	0 39256 27781 2	\$4.99
7777	.177 cal. (4.5 mm)	Pointed Field Pellets	250	987777	Trapped Blister (Peggable); Individual 5.3x1x4 Master 7.2x6.7x4.8	6	0.13	2.46	0 39256 07777 1	\$3.99
7597	.177 cal. (4.5 mm)	Flat-Nosed Pellets	500	987597	Trapped Blister (Peggable); Individual 5.3x.8x4 Master 7.2x6.7x4.9	6	0.14	4.29	0 39256 07597 5	\$4.99
7780	.177 cal. (4.5 mm)	Hollow Point Pellets	500	987780	Trapped Blister (Peggable); Individual 5.3x1x4 Master 7.2x6.8x4.9	6	0.14	4.21	0 39256 87780 7	\$4.99
250	.177 cal. (4.5 mm)	Flat-Nosed, Lead-Free Pellets	250	990250	Trapped Blister (Peggable); Individual 5.4x.8x4 Master 7.2x6.7x4.8	6	0.13	1.96	0 39256 80250 2	\$8.99
7922	.22 cal. (5.5 mm)	Pointed Field Pellets	250	997922	Trapped Blister (Peggable); Individual 5.4x.8x4 Master 8.2x5.7x5.8	12	0.16	6.87	0 39256 07922 5	\$4.99
7785	.22 cal. (5.5 mm)	Hollow Point Pellets	500	987785	Trapped Blister (Peggable); Individual 5.9x1.7x4 Master 7.2x6.7x4.9	3	0.14	3.52	0 39256 87785 2	\$6.99
557	.177 cal. (4.5 mm)	Flat-Nosed Pellets	500	990557	Box (Peggable); Individual 2.8x1.7x1.5 Master 8.8x3.6x3.5	12	0.06	4.11	0 39256 00557 6	\$3.99
257	.177 cal. (4.5 mm)	Flat-Nosed Pellets	250	990257	Box (Peggable); Individual 2.8x1.7x1.5 Master 8.8x3.6x3.5	12	0.06	4.05	0 39256 00257 5	\$2.99
530	.177 cal. (4.5 mm)	BBs in an easy-pour tube	350	990530	Bulk (Peggable); Individual 1x1x3.3 Master 10.2x5.2x4.2	50	0.13	14.33	0 39256 20530 3	\$1.49
980530	.177 cal. (4.5 mm)	BB Tube PDQ (12 350 count BB tubes)	12	980530	Trapped Blister (Peggable); Individual 7.9x6.3x3.4 Master 8.9x6.6x3.9	12	0.13	4.07	0 39256 20530 3	\$2.49
7535	.177 cal. (4.5 mm)	Carded BB Tube	350	997535	Trapped Blister (Peggable); Individual 2.5x1.1x7 Master 7.3x4.9x5	12	0.10	3.92	0 39256 07535 7	\$2.49
0024	.177 cal. (4.5 mm)	BB Bottle in handy plastic bottle	2,400	980024	Individual; Individual 3.2x1.7x4.3 Master 10.2x4.3x5.1	6	0.13	11.90	0 39256 20024 7	\$5.99
0040	.177 cal. (4.5 mm)	BB Bottle in handy plastic bottle	4,000	980040	Individual; Individual 3.2x1.7x6 Master 10.2x4.2x6.8	6	0.17	19.0	0 39256 20040 7	\$8.99
0060	.177 cal. (4.5 mm)	BB Bottle in handy plastic bottle	6,000	980060	Individual; Individual 3.7x2.4x5.6 Master 8.2x6.1x6.3	4	0.1 8	18.78	0 39256 20060 5	\$12.99

**⚠ WARNING** THIS PRODUCT CAN EXPOSE YOU TO LEAD, WHICH IS KNOWN TO THE STATE OF CALIFORNIA TO CAUSE CANCER AND BIRTH DEFECTS OR OTHER REPRODUCTIVE HARM. FOR MORE INFORMATION GO TO [www.p65warnings.ca.gov](http://www.p65warnings.ca.gov).

## CO2 Cylinders

Model No.	Description	Quantity	Item No.	Packaging & Pack Size (W/D/H)	Master Pack	Master Cu. Ft.	Master Weight	UPC	MSRP
7580	12 gm CO2 cylinders	5	997580	Box; Individual 3.8x.8x4.5 Master 7.1x4.2x5.5	12	0.10	5.78	0 39256 07580 7	\$4.99
7015	12 gm CO2 cylinders	15	997015	Box; Individual 3.7x2.2x3.5 Master 11.5x4.8x4	6	0.13	8.38	0 39256 07015 4	\$12.99
7025	12 gm CO2 cylinders	25	997025	Box; Individual 3.7x3.6x3.6 Master 11.4x7.7x4.3	6	0.22	13.49	0 39256 07025 3	\$17.99
584	12 gm CO2 cylinders, bulk-packed (Not shown)	400	990584	Box Bulk; Master 14.5x16.7x6.7	1	0.94	36.60	0 39256 00584 2	\$239.99 CASE

Model 7781



Model 7777



Model 7597



Model 7780



Model 250



Model 7722



Model 7785



Model 557



Model 257



Model 530



Model 7535



Model 0024



Model 0040



Model 0060



Model 7580



Model 7015



Model 7025



Model 980530





# Daisy Accessories

## Model 5845 Shooting Glasses Amber

Amber colored stylish wrap-around design with side shields for added protection. Meets ANSI Z87.1 safety standard.

Model 5845



## Model 5850 Shooting Glasses Clear

Clear stylish wrap-around design with side shields for added protection. Meets ANSI Z87.1 safety standard.

Model 5850



Model 7951



## Model 7951 Acculaser® Laser Sight

Features include: fits standard 3/8" dovetail rifle mounts; adjustable windage and elevation. Remote touch pad locates anywhere for shooting comfort.

Model 7809



## Model 7809 Electronic Point Sight™

Adjustable for windage and elevation; lighted red dot aiming point. Mounts on any rifle with standard 3/8" dovetail.

## Model 808 Air Rifle Scope

4 x 15 scope. Adjustable for windage and elevation. Features include: Cross-hair reticle, fogproof, shockproof and color corrected.

Model 808



## Model 5835 Shoot-N-C® Self-adhesive Airgun Targets

Adhesive-backed targets show an orange halo when they are shot. Apply to any safe target surface. Package of 60 1-inch, 30 2-inch and 20 3-inch targets on card.

## Model 408 5-Meter BB Targets

Official NRA 5-meter airgun targets. Pad of 50 targets. Poly bagged and peggable. 10 pads per case.

Model 408



Model 409



## Model 409 10-Meter Airgun Targets

Official NRA 10-meter airgun targets. Pad of 50 targets. Poly bagged and peggable. 10 pads per case.

Model 876



## Model 873 60 ct. ShatterBlast® Clay Targets

ShatterBlast® targets are biodegradable and non-toxic. Box of 60 2-inch clay disks.

## Model 872 ShatterBlast® Clay Targets with Holders

Clamshell package. Four high-impact target stakes and eight ShatterBlast® breakable targets.

## Model 876 ShatterBlast® SixShooter Target System

Holds six ShatterBlast® target disks. Every time a target disk is shot, another drops into view. Includes 12 ShatterBlast® target disks and 2 target stakes.

Model 5835



Model 873



Model 872



Model No.	Description	Item No.	Packaging & Pack Size (W/D/H)	Master Pack	Master Cu. Ft.	Master Weight	UPC	MSRP
808	4 X 15 Air Rifle Scope	990808	(Peggable); Individual 12.7x2x5.6 Master 13.2x7.6x6.8	4	0.40	1.84	0 39256 00808 9	\$12.99
7809	Electronic Point Sight™	987809	(Peggable); Individual 5.8x1.6x5 Master 6.1x5.3x3.2	4	0.06	0.52	0 39256 07809 9	\$14.99
7951	Acculaser® Laser Sight	987951	(Peggable); Individual 5.2x1.2x4.7 Master 5.6x3.7x6.2	4	0.07	0.76	0 39256 87951 1	\$39.99
5845	Shooting Glasses - Amber	985845	(Peggable); Individual 7.25x3.75x2 Master 13.25x7.5x2.5	4	0.16	1.0	0 39256 85845 5	\$6.99
5850	Shooting Glasses - Clear	985850	(Peggable); Individual 7.25x3.75x2 Master 13.25x7.5x2.5	4	0.16	1.0	0 39256 85850 9	\$6.99
872	ShatterBlast® Clay Targets with Holders	980872	(Peggable); Individual 5.8x1.5x12 Master 12.5x6.7x7.1	4	0.34	2.61	0 39256 80872 6	\$9.99
876	ShatterBlast® SixShooter Target System	990876	Box (Peggable); Individual 3.1x2.2x12.8 Master 12.8x7.8x7	6	0.40	6.46	0 39256 80876 4	\$10.99
873	60 ct. ShatterBlast® Clay Targets	990873	Box; Individual 4.2x2.3x4.2 Master 9.5x7.8x5.7	6	0.24	7.17	0 39256 80873 3	\$10.99
5835	Shoot-N-C® Self-adhesive Airgun Targets	995835	(Peggable); Individual 6.3x.2x7.2 Master 6.7x7.5x4.5	12	0.13	2.15	0 39256 85835 6	\$10.99
408	5-Meter BB Targets	980408	(Peggable); Individual 6.5x.5x10 Master 11.88x8.5x5.5	10 (Pads)	0.32	2.53	0 39256 00408 1	\$4.99
409	10-Meter Airgun Targets	990409	(Peggable); Individual 6.5x.5x10 Master 11.88x8.5x5.5	10 (Pads)	0.32	2.53	0 39256 00409 8	\$4.99



# Daisy Accessories

## Model 870 Rocket Shot Target System

**Finally...an airgun target system that duplicates the fun of shooting clays!**

Just load any empty aluminum can into the Rocket Shot™ silo, press the can down to cock the launcher then shoot the yellow paddle to launch the can. It's fun by yourself or with friends. Standing side-by-side, designate one person to shoot the paddle and take turns shooting cans out of the air. Set up several Rocket Shots for exciting shooting competitions.



Model No.	Description	Item No.	Packaging & Pack Size (W/D/H)	Master Pack	Master Cu. Ft.	Master Weight	UPC	MSRP
870	Rocket Shot Target System	990870	(Peggable); Individual 3.8x3.3x14.2 Master 6.7x3.9x13.8	2	0.21	4.05	0 39256 80870 2	\$19.99



# Daisy Match Grade Rifles

## Start Your Own Shooting Education Program

Daisy® airguns have, for 130 years, been the first gun for most shooters. Today's most accomplished marksmen and most successful hunters will tell you they got started in the shooting sports with a Daisy® BB gun. It all starts here...with a Daisy®.

For youngsters interested in match competition shooting, it all starts with Daisy's 5-meter BB gun shooting education program. Working with premier conservation, civic and religious organizations nationwide, Daisy® has developed the curriculum and the products to teach shooting safety and marksmanship skills to hundreds of thousand of young people annually.

5-meter match competitors compete not just locally but at the state level in order to qualify to shoot at the Daisy National BB Gun Championship Match. Held in Rogers, Arkansas, home of Daisy® Outdoor Products and the Daisy® Airgun Museum, the "Daisy® Nationals" is the nation's largest and longest continuously-running BB gun competition.

The road to the "Daisy® Nationals", to a college scholarship or to international competition begins with the right equipment, the right curriculum and dedicated coaches. The commitment is great but so are the rewards.

If you'd like to start a 5-meter BB or 10-meter pellet rifle or pistol program, please call our **Special Markets Program Department toll-free at (479) 636-1200**. Additional information can be found on the back cover of this catalog.



**Daisy®**  
**National BB Gun**  
CHAMPIONSHIP MATCH

# Daisy Match Grade Rifles

The first Daisy Nationals was held July 8th, 9th, and 10th, 1966, in Dayton, Ohio, at the Grand American Trapshooting Grounds. Ohio's Governor was the Chief Honorary Range Officer and teams were housed on Wright Patterson Air Force Base.

The Joplin, Missouri Jaycees BB Gun Team, the "Joplin Jaycees Sharpshooters," who had won their state match in Crestwood, Missouri, became the first national champions. At the opening ceremonies for our fiftieth annual Daisy Nationals in 2015, we reassembled the members and coach of this first championship team.

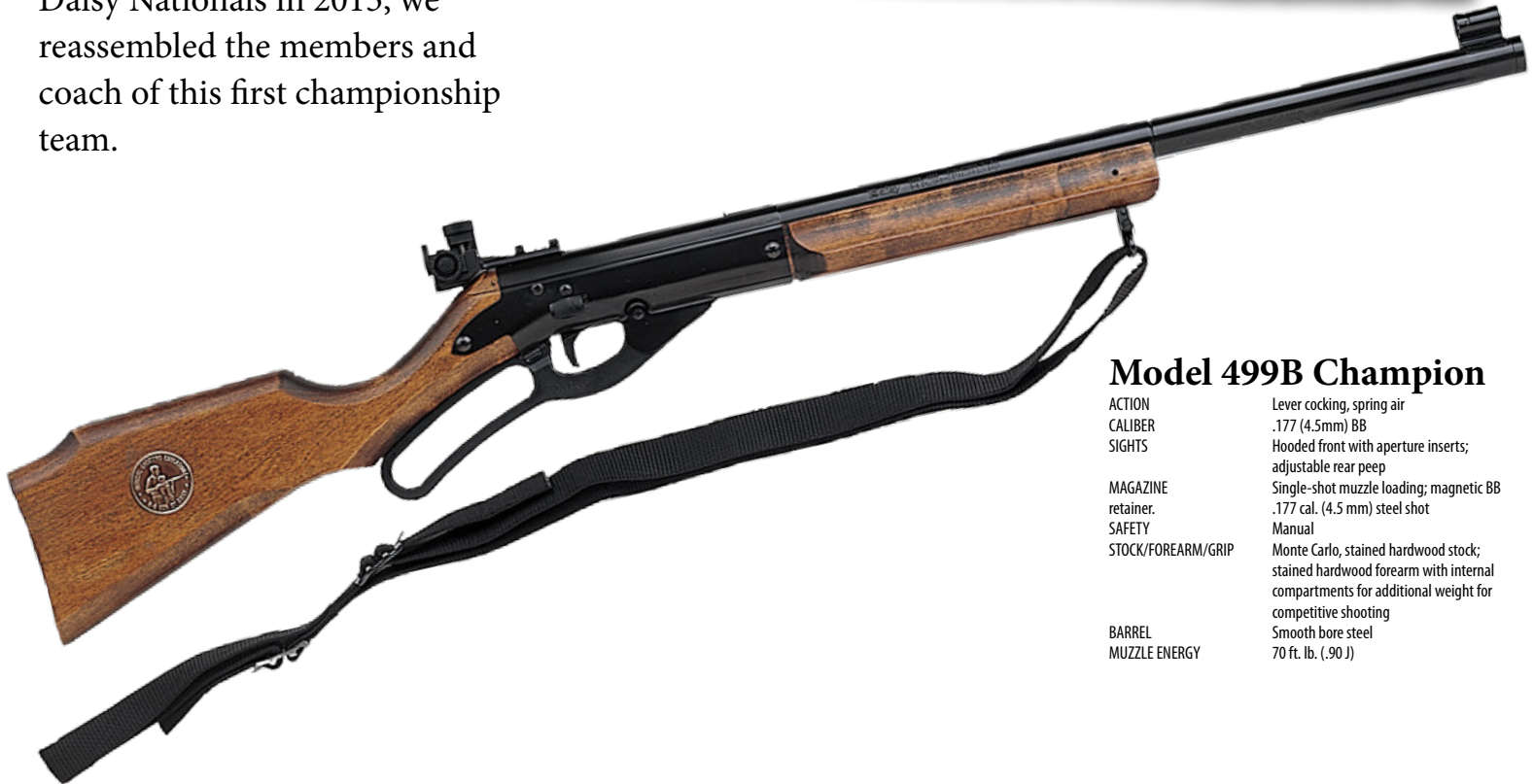

## Model 499B Champion

ACTION	Lever cocking, spring air
CALIBER	.177 (4.5mm) BB
SIGHTS	Hooded front with aperture inserts; adjustable rear peep
MAGAZINE	Single-shot muzzle loading; magnetic BB retainer.
SAFETY	Manual
STOCK/FOREARM/GRIP	Monte Carlo, stained hardwood stock; stained hardwood forearm with internal compartments for additional weight for competitive shooting
BARREL	Smooth bore steel
MUZZLE ENERGY	70 ft. lb. (.90 J)

The Daisy® Champion Model 499B has been dubbed "the most accurate BB gun in the world." This spring air rifle is used by shooting education programs to instruct youth on shooting safety, safe carries, shooting positions and marksmanship skills. The stained solid wood stock features an "Official Shooting Education BB Gun by Daisy" medallion. This gun is a single shot muzzle-loader, designed to be used in a one-on-one coaching situation and comes equipped with a precision micrometer adjustable rear peep sight and a competition sling. The Daisy® Champion is the only BB gun approved for use at the premier BB gun event, the Daisy® National BB Gun Championship Match. If you're interested in shooting incredibly tight groups at 5 meters with a BB gun or if you're interested in starting a shooting class and competitive team, the Daisy® Champion Model 499B is for you.

Model No.	Ammunition	Max. Velocity	Max. Shooting Distance	Overall Length	Weight	Item No.	Packaging & Pack Size (W/D/H)	Master Pack	Master Cu. Ft.	Master Weight	UPC	MSRP
499B	.177 cal. (4.5 mm) BB or pellet	240 fps. (73mps)	177 yds. (162m)	36.25 in. (92cm)	3.10 lbs.	990499	Box; Individual 37.25x6x2.25 Master 38.5x7x7.75	1	1.21	14.2	0 39256 00499 9	\$139.99



# Daisy Match Grade Rifles

## Model 599 \$595<sup>00</sup> Competition Air Rifle

Daisy introduces the ultimate 10-Meter and Silhouette .177 caliber air rifle, the 599 Competition Air Rifle. Features:

- Vertical and length of pull adjustment
- Adjustable comb
- Straight-pull T-handle
- Ambidextrous stock
- Cold hammer-forged BSA barrel
- Removable power configurable cylinders (High-power silhouette cylinders sold separately)
- Pressure gauge and quickfill
- Hooded front sight, diopter rear sight
- Also equipped with integral 10.8mm dovetailed scope rail
- Sling rail

Shoot the entire match without refilling the cylinder!



The Avanti 887 Gold Medalist sets a new standard for competition shooters. We've added a handsome wood laminate stock and our finest competition sights. A properly filled cylinder will get a competitor through an entire match. Includes rail adapter.



Competitive shooters, from local matches to national competitions, require a unique combination of superior accuracy and exceptional balance. The Model 753W and the 753S is specially designed and engineered for the intermediate competitive shooter. Dollar for dollar, it delivers more quality and accuracy than any rifle in its class. The head of the class of 10-meter competition.



### Model 887

<b>ACTION</b>	CO2 power single-shot bolt
<b>BARREL</b>	Lothar Walther™ rifled high-grade steel barrel; crowned, 12 lands and grooves, right-hand twist. Precision bore sized for match pellets.
<b>SIGHTS</b>	Front globe sight with changeable aperture inserts, diopter rear sight with micrometer adjustable rear
<b>STOCK/FOREARM</b>	Match style laminated wood stock with raised cheek piece and adjustable length
<b>SAFETY</b>	Manual crossbolt trigger block with red indicator
<b>TRIGGER PULL LENGTH</b>	Adjustable from 12 in. to 13.75 in.
<b>TRIGGER PULL RECEIVER</b>	Adjustable trigger to 2.0 lbf. Die-cast metal with full-cut loading port
<b>CAPACITY</b>	Single shot .177 cal. (4.5 mm) pellet
<b>MUZZLE ENERGY</b>	4.28 ft. lb.

### Model 753W

<b>ACTION</b>	Pneumatic single-pump cocking lever; straight pull bolt
<b>BARREL</b>	Lothar Walther™ rifled high-grade steel barrel; crowned, 12 lands and grooves, right-hand twist. Precision bore sized for match pellets.
<b>SIGHTS</b>	Front globe sight with changeable aperture inserts, diopter rear sight with micrometer adjustable rear
<b>STOCK/FOREARM</b>	Full-length, match-style stock with raised cheek piece and adjustable length
<b>SAFETY</b>	Manual crossbolt trigger block with red indicator
<b>RECEIVER</b>	Die-cast metal with full-cut loading port
<b>CAPACITY</b>	Single shot .177 cal. (4.5 mm) pellet
<b>MUZZLE ENERGY</b>	4.5 ft. lb.

### Model 753S

<b>ACTION</b>	Pneumatic single-pump cocking lever; straight pull bolt
<b>BARREL</b>	Lothar Walther™ rifled high-grade steel barrel; crowned, 12 lands and grooves, right-hand twist. Precision bore sized for match pellets.
<b>SIGHTS</b>	Front globe sight with changeable aperture inserts, diopter rear sight with micrometer adjustable rear
<b>STOCK/FOREARM</b>	Full-length, match-style stock with raised cheek piece and adjustable length
<b>SAFETY</b>	Manual crossbolt trigger block with red indicator
<b>RECEIVER</b>	Die-cast metal with full-cut loading port
<b>CAPACITY</b>	Single shot .177 cal. (4.5 mm) pellet
<b>MUZZLE ENERGY</b>	4.5 ft. lb.

Model No.	Ammunition	Max. Velocity	Max. Shooting Distance	Overall Length	Weight	Item No.	Packaging & Pack Size (W/D/H)	Master Pack	Master Cu. Ft.	Master Weight	UPC	MSRP
887	.177 cal. (4.5 mm) pellet	500 fps. (152mps)	257 yds. (235m)	38.5 in. (97.7cm)	7.3 lbs (3.3 kg)	990887	Box; Individual 42.5x8.5x3.25 Master N/A	1	0.679	9.25	0 39256 20887 8	\$499.99
753W	.177 cal. (4.5 mm) pellet	495 fps (151 mps)	257 yds. (235 m)	39.75" (101 cm)	6.15 lbs. (2.7 kg)	990753 -101	Box; Individual 42.5x8.5x3.25 Master N/A	1	0.679	7.73	0 39256 20753 6	\$449.99
753S	.177 cal. (4.5 mm) pellet	495 fps (151 mps)	257 yds. (235 m)	39.75" (101 cm)	6.25 lbs. (2.83 kg)	990753 -200	Box; Individual 42.5x8.5x3.25 Master N/A	1	0.679	7.73	0 39256 80753 8	\$449.99

# Daisy Match Grade Accessories

## Competition Airgun Accessories

Designed to exacting standards, constructed from the finest materials and built with the finest workmanship, these accessories are precisely what you need to complement your Daisy Match Grade air rifle.

### Model 5899 Rear Sight

Precision micrometer adjustable rear peep sight. For use with Daisy Match Grade 499 Champion

### Model 5996 Rear Sight

Diopter rear sight with micrometer click adjustment for windage and elevation. For use with Daisy Match Grade 887, 753W, 753S, 753 Elite, 888 Medalist, 853 Legend and 853C Legend EX.

### Model 5901 Front Sight

Front globe sight with changeable aperture inserts mounted on competition muzzle weight for exceptional balance. Standard front sight and barrel weight. For use with Daisy Match Grade 887, 753W and 753S.

### Model 154518-000

Standard front barrel weight. For use with Daisy Match Grade 887, 753W and 753S. (barrel weight only)

### Model 169759-000

Set of three additional posts. Fits front sight for the 499 Champion. (Not Shown)

### Model 168968-000

Set of three additional apertures. Fits Front Globe Assy. 154518-000. (Not Shown)

### Model 5881 Daisy Web Position Sling

Adjustable nylon web sling. The web position sling is one inch wide and comes with forearm mounting screw. For use with Daisy Match Grade 499 Champion.

### Model 169277-000 Competition Stock

Full-sized hardwood stock with raised cheek piece and adjustable length. Fits the Model 853 Legend and 853C Legend EX.

### Model 138429-000 Competition Stock

Full-sized hardwood laminate stock with raised cheek piece and adjustable length. Fits the 887 Gold Medalist and Medalist Model 888.

### Model 5904 Repair Kit and CD-ROM

For 853/853C/853CM/753W/753S air rifles. Step-by-step instructions on dismantling and repairing these three Avanti air rifles. Approximately 12 minutes.

### Model 5905 Repair CD-ROM Only

### Model 499 Repair CD-ROM

### Model 853/853C/853CM/753W/753S Repair CD-ROM

### Model 888/887 Repair CD-ROM

### Model 5862 Refillable 2.5 oz. CO2 Cylinder

Fire up to 300 shots with no significant drop in velocity, when properly filled. Fits the 887 Gold Medalist and Medalist Model 888.

### Model 5861 Refill Adapter

Allows refilling of the CO2 cylinder from CO2 tank. Fits the 887 Gold Medalist and Medalist Model 888.

### Model 153001-000 Daisy Cap

World-famous Daisy logo embroidered on a cotton twill hat. One size fits all.

## Traps and Targets

### Model 875 Pellet Trap

Specially designed for pellet shooting only. Heavy-gauge steel front, pellet stopping back and base. Sheet metal side panels. For 10-meter pellet rifle shooting. Size: 17"W x 13"H x 11.5"D.

### Model 5815 5 Meter BB Targe

Daisy 5-meter air rifle targets. Pad of 50 ten-bull target sheets.

### Model 5818 Targets

Daisy 10-meter air rifle targets. Pad of 50 ten-bull target sheets.

## Airgun Ammunition

You and your Daisy Match Grade air rifle deserve ammunition that will let you perform at your best. And Daisy has the high-quality, match grade ammunition to complement your Daisy Match Grade air rifle or pistol. These pellets and BBs are designed for peak performance and total consistency, shot after shot.

Model 5899



Model 5996



Model 169816-000



Model 154518-000



Model 5904



Model 5881



Model 499



Model 169277-000



Model 138429-000



Model 853/853C /853CM/753W /753S



Model 5862



Model 888/887



Model 153001-000



Model 5861



### Model 357 Match Grade Pellets

Target Pellets Select Competition. .177 cal. (4.5 mm), 0.565 Grams, flat-nosed lead airgun pellets. 250 per tin.

### Model 515 Match Grade Precision Ground Shot

Daisy's top-of-the-line steel shot. Super accurate. .177 cal. (4.5 mm) BBs. 1050 BBs per box. Packed 12 per case.

### Model 0005 Bulk BB Shot

50-pound bucket of .177 cal. (4.5 mm) BBs. (Not Shown)

Model 5815



Model 5818

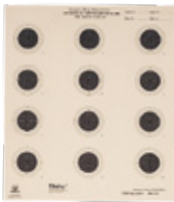

Model 875



Model 515



Model 985357-001





# Daisy Match Grade Rifles



## Model 1903 Drill Rifle

**ACTION**

Bolt is the only functional part

**SIGHTS**

Blade and ramp front, fixed

open rear

**STOCK/FOREARM**

Full-length, black composite stock

At first glance, the Daisy drill rifle looks like a fully functional 1903-A1 Springfield rifle with a black synthetic stock. But the only feature this rifle shares with a firearm is the opening bolt. The design and durable steel components and synthetic stock make this drill rifle capable of withstanding the abuse that is inherent in drill team use.

Model No.	Ammunition	Max. Velocity	Max. Shooting Distance	Overall Length	Weight	Item No.	Packaging & Pack Size (W/D/H)	Master Pack	Master Cu. Ft.	Master Weight	UPC	MSRP
1903 Black	N/A	N/A	N/A	43.2"	8.4 - 8.6 lbs.	991938- 011	Box; Individual 44.5x7.38x3.38 Master N/A	1	0.641	9.40	N/A	\$250.00

## 4-H Shooting Sports Programs

Hundreds of thousands of young people annually participate in 4-H Shooting Sports Programs where they are taught the proper handling of airguns, small bore and black powder rifles, shotguns and archery equipment. To help local 4-H Clubs begin programs, Daisy has assembled a variety of shooting education kits containing airguns, ammunition, targets, instructor curriculum guides and more. 4-H training and shooting equipment is one important way Daisy keeps on target with its goal of teaching marksmanship and shooting safety. [www.4-hshootingsports.org](http://www.4-hshootingsports.org)

## Education. Instruction. Competition.

The American Legion, the National Rifle Association (NRA), the National Guard Youth Marksmanship Program and Daisy have teamed together to make instruction materials and equipment available. This cooperative effort introduces thousands of young people to the shooting sports at more than 16,000 American Legion Posts nationwide. Thanks to their pinpoint accuracy, Avanti's .177 caliber (4.5 mm) Legend 853, Legend EX 853C, 888 Medalist and 887 Gold Medalist are the air rifles most often used in this exciting program. Skills learned there may carry these young shooters on to competitive programs at the local, state and national level.

## Program Development Resource Materials

Daisy and the organizations listed below offer training and education materials for camps, clubs and other associations developing effective airgun training programs. If you're interested, we urge you to take advantage of these materials:

- **10-Lesson Guide** — A complete curriculum for shooting sports programs. Download: [www.daisy.com/education](http://www.daisy.com/education)
- **Airgun Range Plans** — An outline for the proper construction of an airgun range.
- **Safety Poster** — An easy-to-use guide and poster that illustrates BB and pellet gun safety.

**For more information** on the Daisy Official Shooting Awards Program or Daisy's Program Development Resource Materials, contact:

**Daisy Outdoor Products, Special Market Programs Dept., P.O. Box 220, Rogers, AR 72757-0220 U.S.A.**

## NSSF Information Brochures

The National Shooting Sports Foundation (NSSF) has a number of informational brochures. Topics include firearms safety in the home, information for parents whose children are interested in shooting, general shooting sports information and more. These materials are available free of charge in limited quantities to teachers or counselors for use in shooting education programs.

For more information, contact: **National Shooting Sports Foundation, Shooting Sports Development Office, 11 Mile Hill Road, Newtown, CT 06470-2359 • [www.nssf.org](http://www.nssf.org) • (203) 426-1320**

## Program Information

### American Legion Junior Shooting Sports Program

Details available from: Assistant Director of Americanism and Youth, Mike Buss, e-mail: [mbuss@legion.org](mailto:mbuss@legion.org)  
The American Legion, P.O. Box 1055, Indianapolis, IN 46206, (317) 630-1249

### Civilian Marksmanship Program

Bldg. 3, P.O. Box 576, Port Clinton, OH 43452, 419-635-2141, [www.odcmp.org](http://www.odcmp.org)

### NRA Junior Shooting Program

Details available from: Safety and Education Division, The National Rifle Association of America, 11250 Waples Mill Road, Fairfax, VA 22030, (703) 267-1000

### USA Shooting

1 Olympic Plaza, Colorado Springs, CO 80909, (719) 866-4670, [www.usashooting.com](http://www.usashooting.com)

### 4-H Shooting Sports

Call Your County Extension Agent, [www.4-hshootingsports.org](http://www.4-hshootingsports.org)

## It All Starts Here, With a Daisy®.

86% of outdoors enthusiasts surveyed report that they took their first shot with a BB gun. 88% of those who started with a BB gun started with a Daisy®.

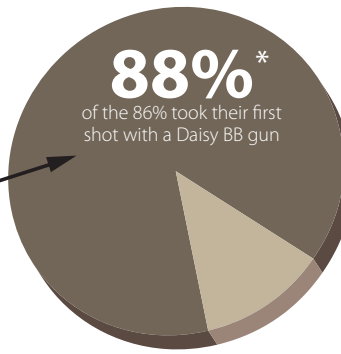
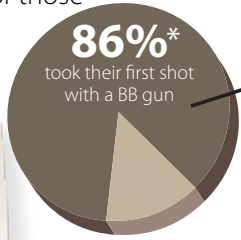

Daisy National BB Gun Championship Match, Rogers, Arkansas



## Generation after Generation.....

A Daisy® owner is a repeat customer who will purchase a Daisy® - for themselves or another generation. 86% of those surveyed have purchased or plan to purchase a Daisy® BB gun.

# 1,000,000 Young Shooters

## Daisy® Reaches 1,000,000 Young Shooters.

By partnering with leading conservation and youth training organizations Daisy® reaches over **one million** young people annually.



## Daisy Shooting Events Reach New Customers.

Daisy's innovative inflatable range design is used exclusively by the National Wild Turkey Federation's highly-respected youth outreach and education program, JAKES Take Aim. In every state, this one-on-one instruction and product demonstration is proven to attract new young and first-time shooters. Intercept surveys at outdoor events and store events indicate that an average of 51% of those shooting at our inflatable ranges are first time shooters.

# 51%\*

**of those shooting at our  
inflatable ranges are first  
time shooters**



\* Intercept surveys at outdoor sports stores and events



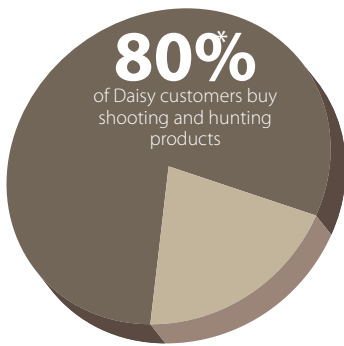

## Daisy® Customers Buy Other Shooting and Hunting Products.

**80%** of those surveyed participate in one or more shooting sports, such as upland, waterfowl, small and big game hunting, blackpowder and bow hunting, shotgun, rifle and pistol hunting and target shooting.

## 33% of those surveyed shop for related products more than 12 times per year.

- Your customers take their first shot with a Daisy® BB gun.
  - Daisy® owners are repeat customers.
- Daisy® sponsored programs continue to grow, reaching 1,000,000 young shooters annually.
  - Daisy's inflatable ranges reach first time shooters.
  - Daisy® owners participate in other shooting sports and shop your stores.
- Daisy's shooting safety and marksmanship education program involves thousands of youth and family members nationwide.
  - Daisy's social media campaign promotes its brand and products.

**When someone takes their first shot with a Daisy®, they become a shooting sports customer for a lifetime.**

# Daisy® National BB Gun CHAMPIONSHIP MATCH

## The Nationals is the Tip of the Iceberg.

*Teams of seven athletes qualify each year at their state match to attend the Daisy® National BB Gun Championship Match.* These participants represent the best of the best. Nationwide, there are hundreds of coaches who teach the Daisy® shooting safety curriculum in classrooms, practice with their teams on the range and compete in state matches. Coaches, parents, siblings and extended families who travel with these young athletes are all Daisy® customers – and avid shooting sports customers.



Keep up with Daisy and join the conversation. We look forward to it!

# Daisy® Outdoor Products

479-636-1200 • fax 479-636-1601 • [www.daisy.com](http://www.daisy.com)  
Daisy Outdoor Products reserves the right to make specification changes without notice.